

- Note:
- (1). Input Signal: 4~20mA, 2~10V, 1~5V.
 - (2). Output Signal: 4~20mA, 2~10V.
 - (3). Using less than 5A current for "A,B,C,D,E,F".
 - (4). P4 will come on when the actuator doesn't operate after 15sec.

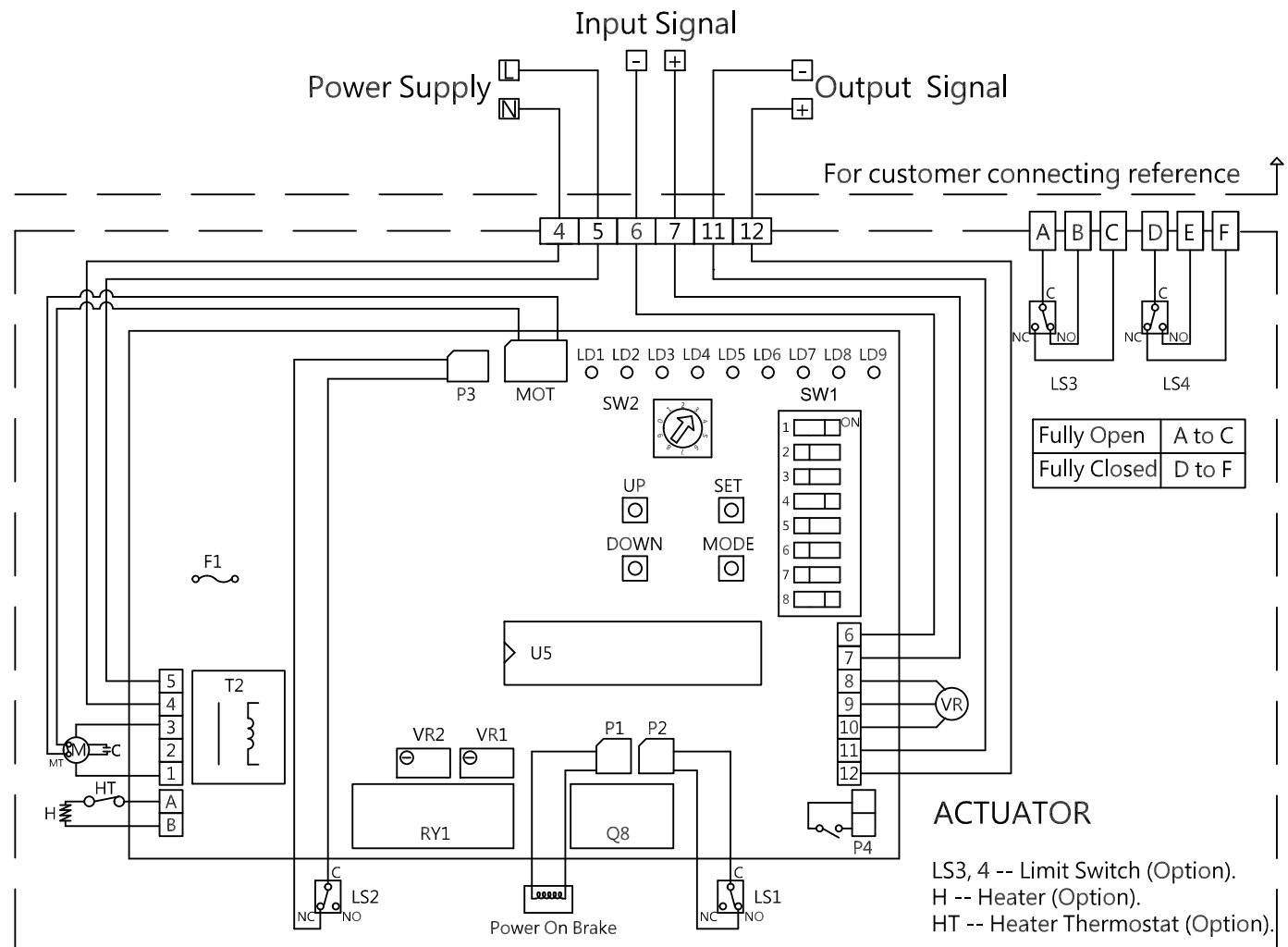

Wiring Diagram NO: 02-006-18-02-03-02-3-001

Rev	1.0	Signature	Date	S1300 · S2000 · S2600
Designed				Power Supply : 220~240VAC 1-Phase
Drawn	Wen Yao	2018/08/02		Modulating Control
Checked	Ming Hung	2018/08/15		50% Duty Cycle
Approved				