

Note:

- (1). Using the hand-wheel to turn the actuator to 45 degree before test.(If the operating direction is opposite, please change any two of U, V, W).
- (2). Using less than 5A current for "A,B,C,D,E,F".

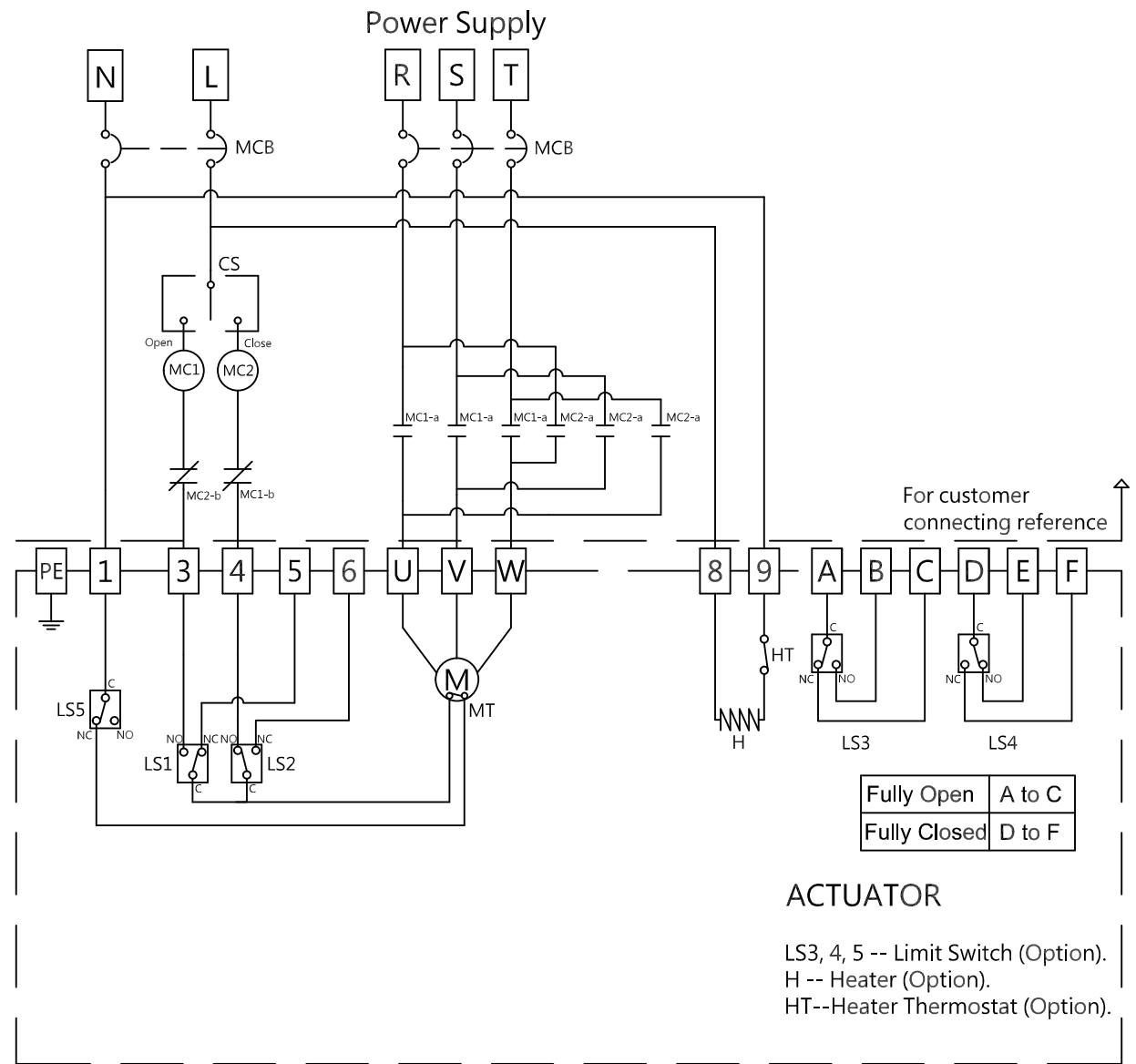

Wiring Diagram NO: 05-007-21-03-02-01-3-001

Rev	1.0	Signature	Date	CM100 · CM200 · CM300 · CM400 · CM500 · CM600 Power Supply : 440~480VAC 3-Phase Floating Control 30% Duty Cycle
Designed				
Drawn	Wen Yao	2018/09/05		
Checked	Ming Hung	2018/09/05		
Approved				