

Note:

- (1). Modulating Board
 Input Signal : 4~20mA, 1~5V, 2~10V.
 (it is suggested to use the shielding wire and its length should not exceed 30m)
 Output Signal : 4~20mA, 2~10V.
- (2). Using less than 3A current for "A,B,C,E,F".

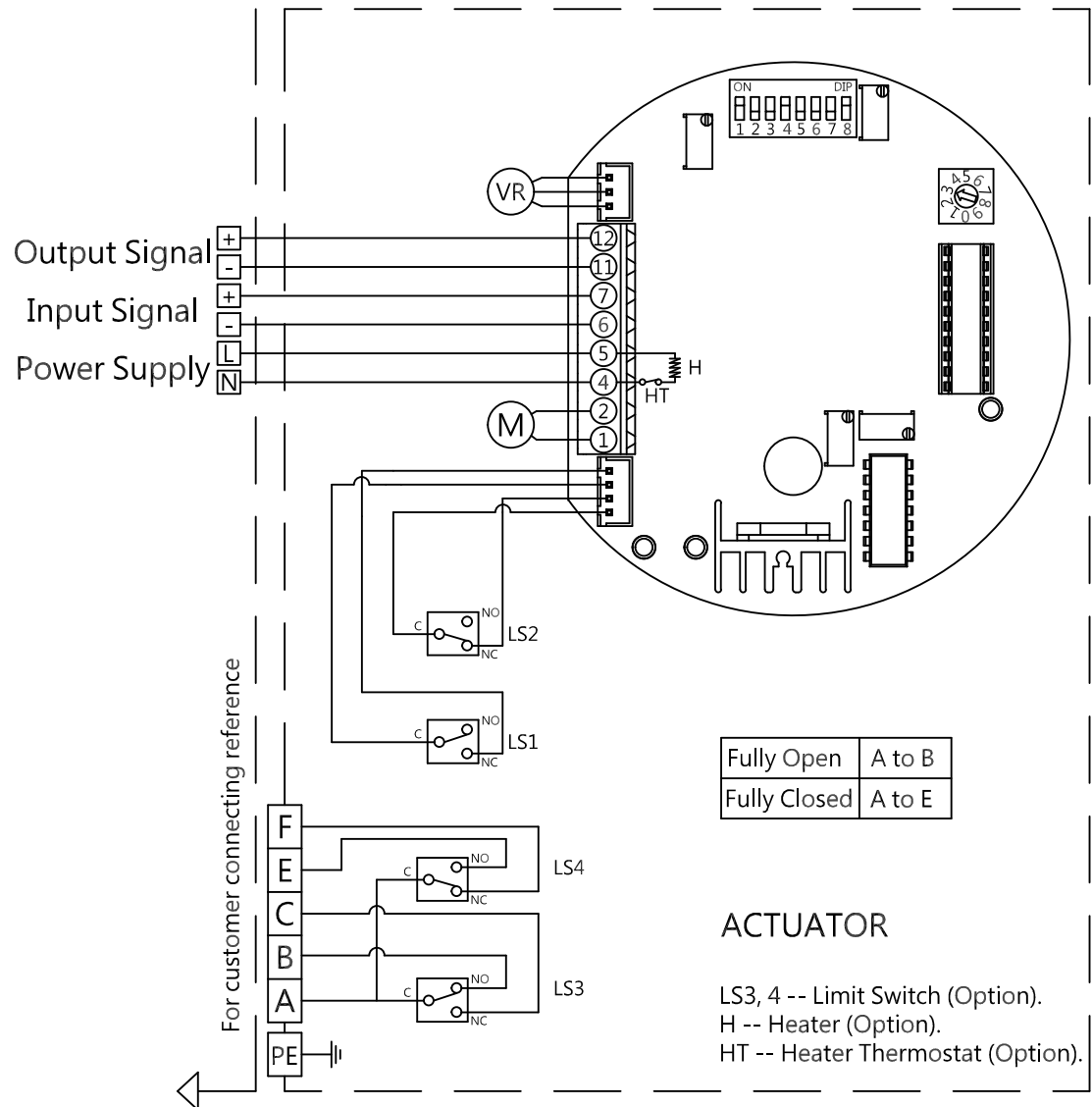

Wiring Diagram NO: 01-020-18-02-03-03-3-001

Rev	1.0	Signature	Date	OM1 · OMA · OMAM Power Supply : 220~240VAC 1-Phase Modulating Control 75% Duty Cycle
Designed				
Drawn	MING YU	2018/08/15		
Checked	Ming Hung	2018/09/01		
Approved				