

Note:

- (1). "N" connects to 1, "L" connects to 7.
- (2). "L" connects to 3 for "OPEN", "L" connects to 4 for "CLOSE".
- (3). Using less than 5A current for "A,B,C,D,E,F".

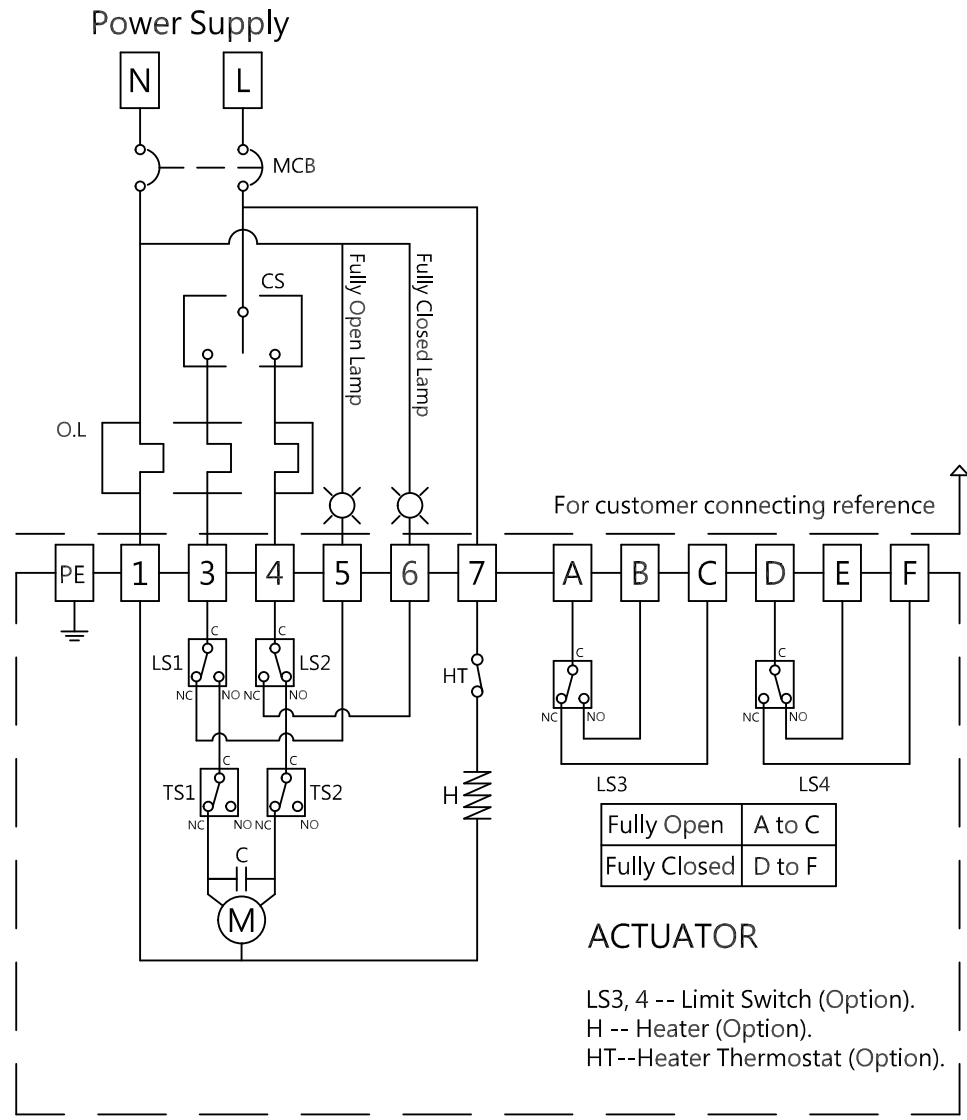

Wiring Diagram NO: 06-014-18-02-02-01-3-001

Rev	1.0	Signature	Date	OME2~OME8 Power Supply : 220~240VAC 1-Phase Floating Control 30% Duty Cycle
Designed				
Drawn	Wen Yao	2018/09/04		
Checked	Ming Hung	2018/09/04		
Approved				