

Note:

- (1). "N" connects to 1, "L" connects to 3.
"L" connects to 7 for Heater (Option).
- (2). 4 connects to 5 for "OPEN".
4 connects to 6 for "CLOSE".
- (3). Using less than 5A current for "A,B,C,D,E,F".

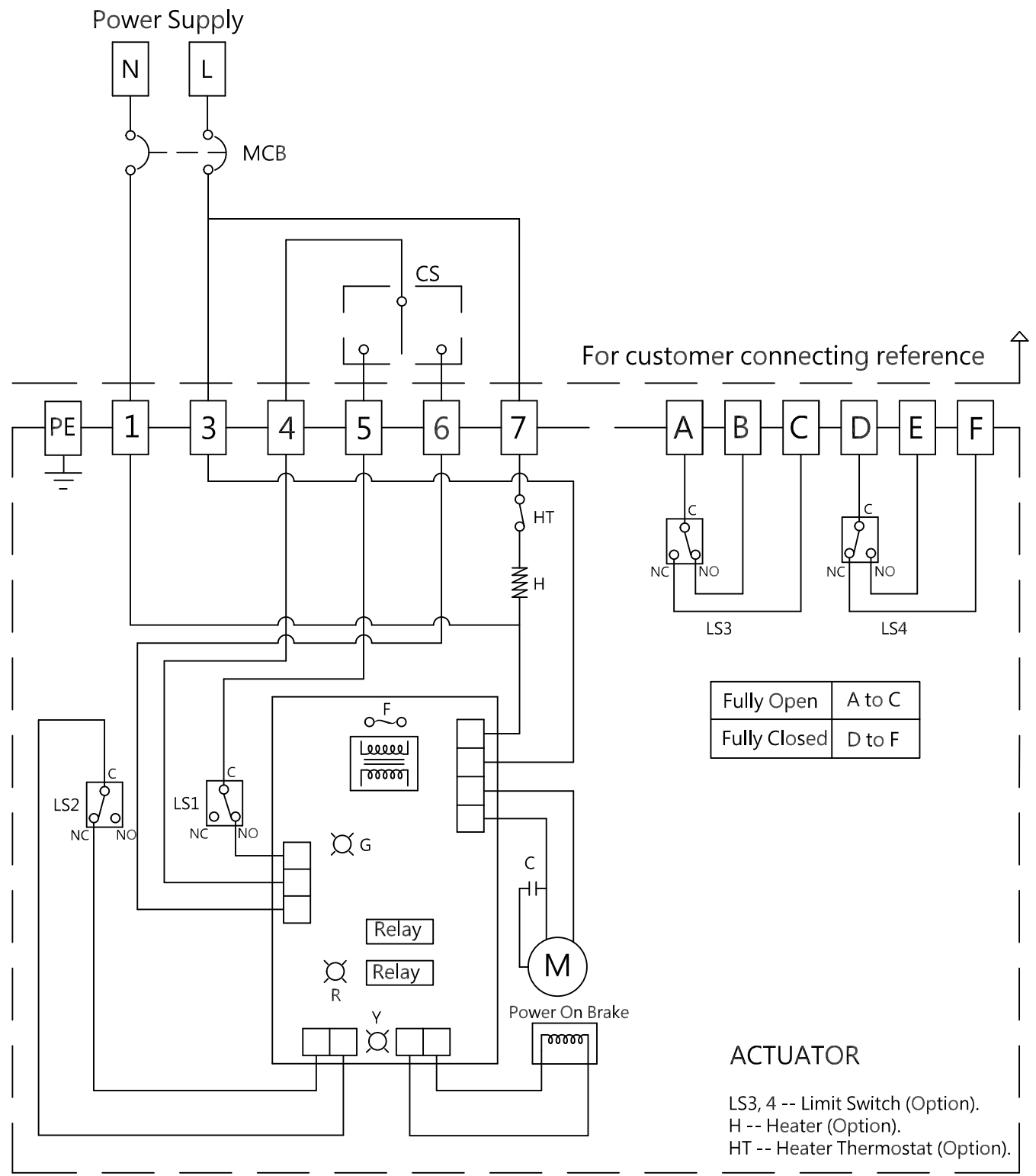

Wiring Diagram NO: 07-001-17-02-02-3-001

Rev	1.0	Signature	Date	SE500
Designed				Power Supply : 110~120VAC 1-Phase
Drawn	Wen Yao	2018/08/02		Floating Control
Checked	Ming Hung	2018/08/15		50% Duty Cycle
Approved				