

Note:

- (1). "N" connects to 1.
- (2). "L" connects to 3 for "OPEN", "L" connects to 4 for "CLOSE".

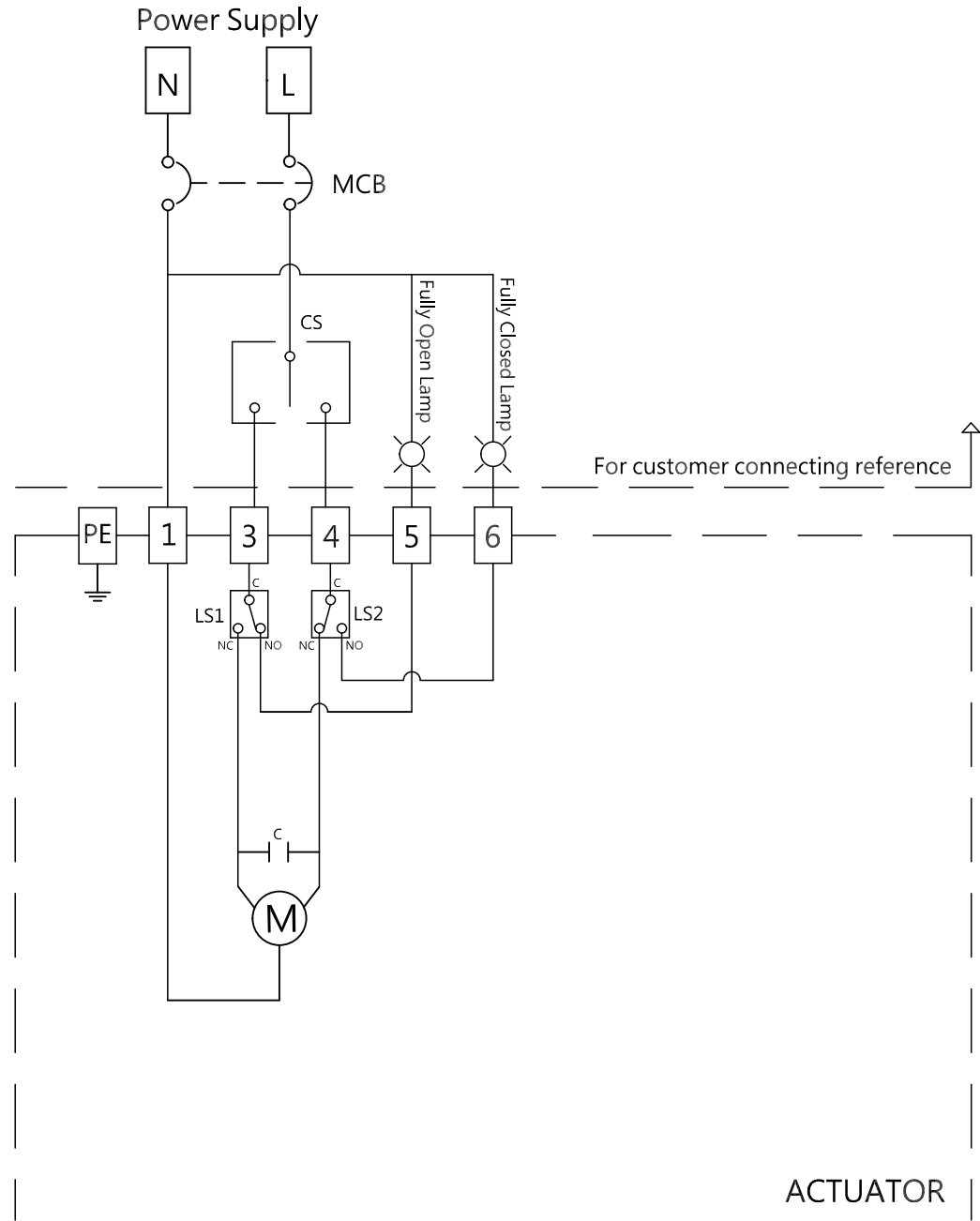

Wiring Diagram NO: 04-03-18-02-02-01-3-001

Rev	1.0	Signature	Date	T06 · T15
Designed				Power Supply : 220~240VAC 1-Phase
Drawn		Wen Yao	2018/08/02	Floating Control
Checked		Ming Hung	2018/08/16	30% Duty Cycle
Approved				

ACTUATOR